

Surface Mount Microwave Schottky Detector Diodes

Technical Data

Features

- **Surface Mount SOT-23/SOT-143 Package**
- **High Detection Sensitivity:**
 up to 50 mV/μW at 915 MHz
 up to 35 mV/μW at 2.45 GHz
 up to 25 mV/μW at 5.80 GHz
- **Low Flicker Noise:**
 -162 dBV/Hz at 100 Hz
- **Low FIT (Failure in Time) Rate***
- **Tape and Reel Options Available**

* For more information see the Surface Mount Schottky Reliability Data Sheet.

HSMS-2860 Package Lead Code Identification

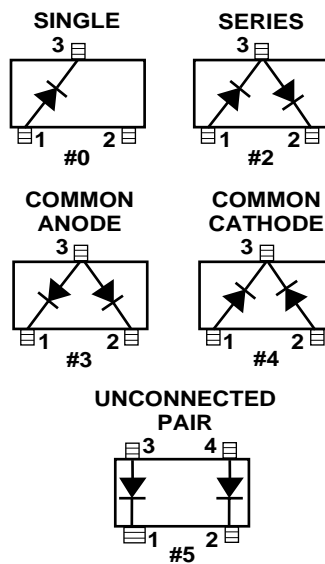

HSMS-2850 Package Lead Code Identification

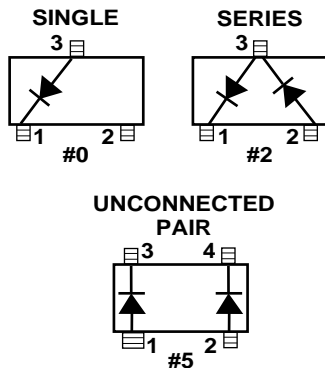

HSMS-2850 Series HSMS-2860 Series

Description

Hewlett-Packard's HSMS-2850 family of zero bias Schottky detector diodes and the HSMS-2860 family of DC biased detector diodes have been designed and optimized for use from 915 MHz to 5.8 GHz. They are ideal for RF/ID and RF Tag applications requiring small and large signal detection, modulation, RF to DC conversion or voltage doubling.

Available in various package configurations, these two families of detector diodes provide low cost solutions to a wide variety of design problems. Hewlett-Packard's manufacturing techniques assure that when two diodes are mounted into a single SOT-23 or SOT-143 package, they are taken from adjacent sites on the wafer, assuring the highest possible degree of match.

DC Electrical Specifications, $T_A = +25^\circ\text{C}$, Single Diode

Part Number HSMS-	Package Marking Code ^[1]	Lead Code	Configuration	Maximum Forward Voltage V_F (mV)		Typical Capacitance C_T (pF)
2850 2852 2855	P0 P2 P5	0 2 5	Single Series Pair ^[2,3] Unconnected Pair ^[2,3]	150	250	0.30
2860 2862 2863 2864 2865	T0 T2 T3 T4 T5	0 2 3 4 5	Single Series Pair ^[2,3] Common Anode ^[2,3] Common Cathode ^[2,3] Unconnected Pair ^[2,3]	250	350	0.30
Test Conditions				$I_F = 0.1 \text{ mA}$	$I_F = 1.0 \text{ mA}$	$V_R = -0.5 \text{ V to } -1.0 \text{ V}$ $f = 1 \text{ MHz}$

Notes:

1. Package marking code is in white.
2. ΔV_F for diodes in pairs is 15.0 mV maximum at 1.0 mA.
3. ΔC_T for diodes in pairs is 0.05 pF maximum at -0.5 V .

RF Electrical Specifications, $T_A = +25^\circ\text{C}$, Single Diode

Part Number HSMS-	Typical Tangential Sensitivity TSS (dBm) @ f =			Typical Voltage Sensitivity γ (mV/ μW) @ f =			Typical Video Resistance RV (K Ω)
	915 MHz	2.45 GHz	5.8 GHz	915 MHz	2.45 GHz	5.8 GHz	
2850 2852 2855	-57	-56	-55	40	30	22	8.0
Test Conditions	Video Bandwidth = 2 MHz Zero Bias			Power in = -40 dBm $R_L = 100 \text{ K}\Omega$, Zero Bias			
2860 2862 2863 2864 2865	-57	-56	-55	50	35	25	5.0
Test Conditions	Video Bandwidth = 2 MHz $I_b = 5 \mu\text{A}$			Power in = -40 dBm $R_L = 100 \text{ K}\Omega$, $I_b = 5 \mu\text{A}$			

Absolute Maximum Ratings, $T_a = +25^\circ\text{C}$, Single Diode

Symbol	Parameter	Absolute Maximum ^[1]	
		HSMS-285x	HSMS-286x
P_T	Total Device Dissipation ^[2]	75 mW	250 mW
P_{IV}	Peak Inverse Voltage	2.0 V	4.0 V
T_J	Junction Temperature	150°C	150°C
T_{STG}	Storage Temperature	-65°C to 150°C	-65°C to 150°C
T_{OP}	Operating Temperature	-65°C to 150°C	-65°C to 150°C

Notes:

1. Operation in excess of any one of these conditions may result in permanent damage to the device.
2. CW Power Dissipation at $T_{LEAD} = +25^\circ\text{C}$. Derate linearly to zero at maximum rated temperature.

ESD WARNING: Handling Precautions Should Be Taken To Avoid Static Discharge.

Equivalent Circuit Model

HSMS-2850, HSMS-2860;
Singles

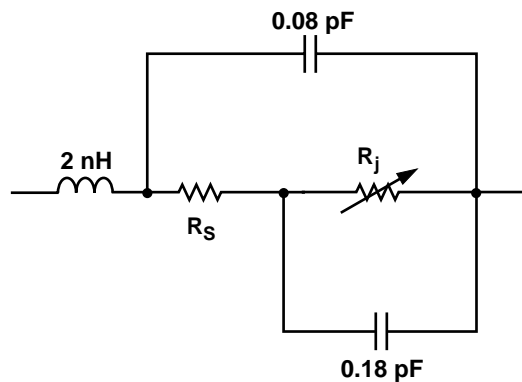

R_S = series resistance (see Table of SPICE parameters)

$$R_j = \frac{8.33 \times 10^{-5} \text{ nT}}{I_b + I_s}$$

where

I_b = externally applied bias current in amps

I_s = saturation current (see table of SPICE parameters)

T = temperature, °K

n = identity factor (see table of SPICE parameters)

SPICE Parameters

Parameter	Units	HSMS-285X	HSMS-286X
B_V	V	3.8	7.0
C_{J0}	pF	0.18	0.18
E_G	eV	0.69	0.69
I_{BV}	A	3×10^{-4}	10^{-5}
I_S	A	3×10^{-6}	5.0×10^{-8}
N		1.06	1.08
R_S	Ω	25	5.0
P_B (VJ)	V	0.35	0.65
P_T (XTI)		2	2
M		0.5	0.5

Typical Parameters, Single Diode

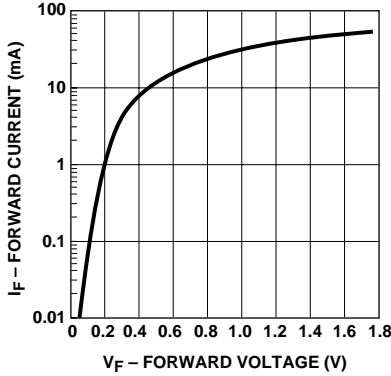

Figure 1. Typical Forward Current vs. Forward Voltage, HSMS-2850 Series.

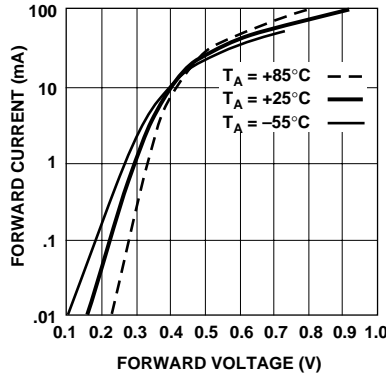

Figure 2. Typical Forward Current vs. Forward Voltage at Temperature, HSMS-2860 Series.

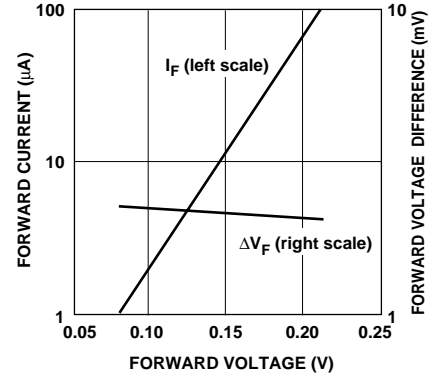

Figure 3. Typical Forward Voltage Match, HSMS-2860 Pairs.

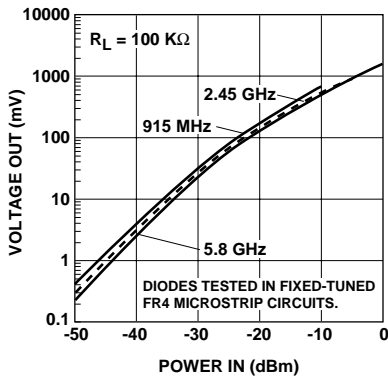

Figure 4. +25°C Output Voltage vs. Input Power, HSMS-2850 at Zero Bias, HSMS-2860 at 3 μ A Bias.

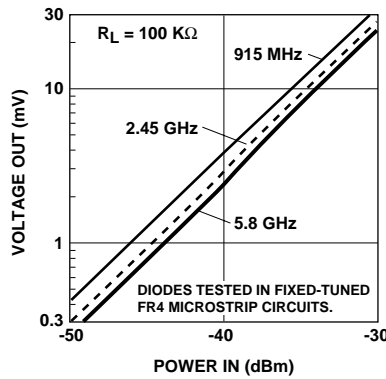

Figure 5. +25°C Expanded Output Voltage vs. Input Power. See Figure 4.

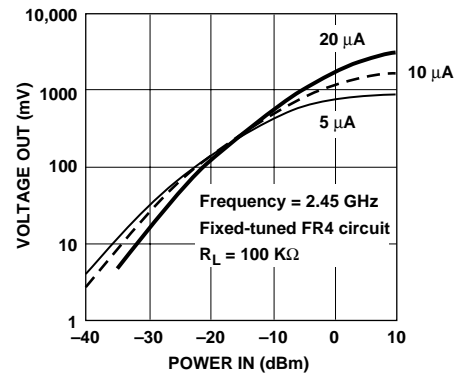

Figure 6. Dynamic Transfer Characteristic as a Function of DC Bias, HSMS-2860.

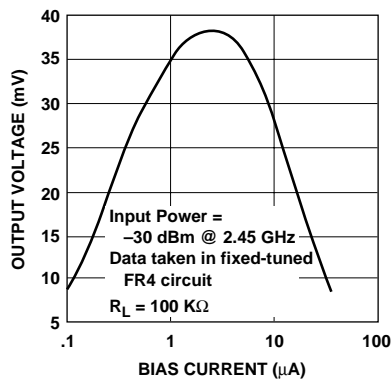

Figure 7. Voltage Sensitivity as a Function of DC Bias Current, HSMS-2860.

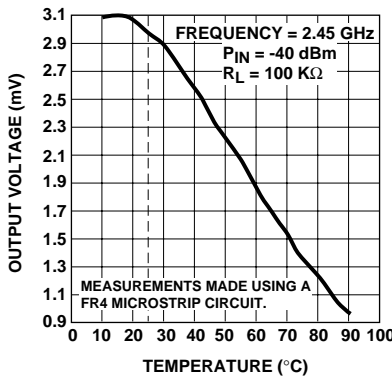

Figure 8. Output Voltage vs. Temperature, HSMS-2850 Series.

Applications Information

See the HSMS-285A data sheet.

Profile Option Descriptions

-BLK = Bulk

-TR1 = 3K pc. Tape and Reel, Device Orientation; See Figures 9 and 10

-TR2 = 10K pc. Tape and Reel, Device Orientation; See Figures 9 and 10

Tape and Reeling conforms to Electronic Industries RS-481, "Taping of Surface Mounted Components for Automated Placement."

Ordering Information

Specify part number followed by option under. For example:

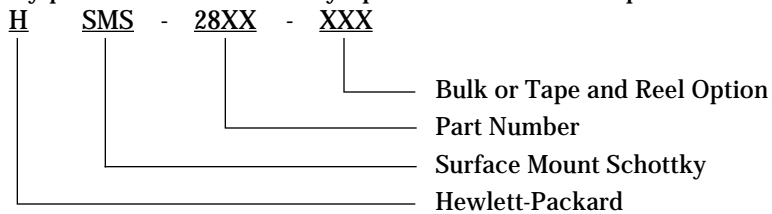

Package Characteristics

Lead Material	Alloy 42
Lead Finish	Tin-Lead 85/15%
Max. Soldering Temp.	260°C for 5 sec.
Min. Lead Strength	2 pounds pull
Typical Package Inductance	2 nH (opposite leads)
Typical Package Capacitance	0.08 pF (opposite leads)

Package Dimensions Outline 23 (SOT-23)

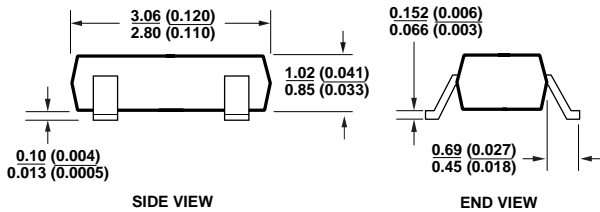
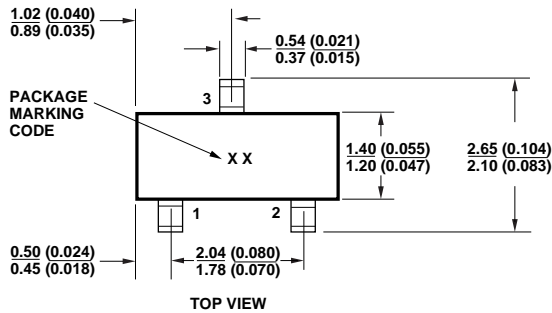

DIMENSIONS ARE IN MILLIMETERS (INCHES)

Outline 143 (SOT-143)

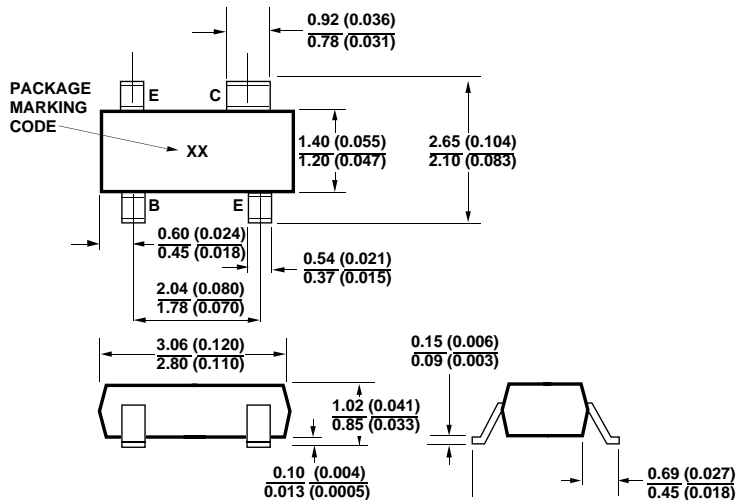

DIMENSIONS ARE IN MILLIMETERS (INCHES)

Device Orientation

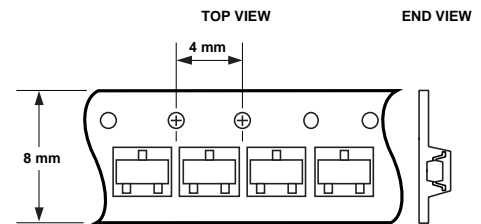
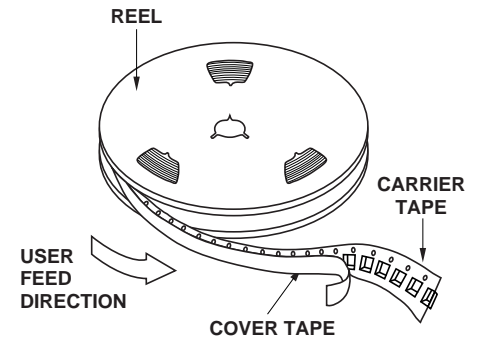

Figure 9. Options -TR1, -TR2 for SOT-23 Packages.

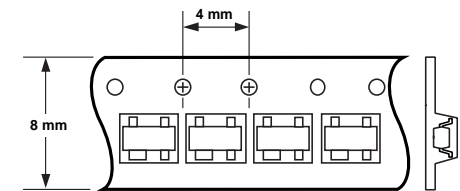

Figure 10. Options -TR1, -TR2 for SOT-143 Packages.

www.hp.com/go/rf

For technical assistance or the location of your nearest Hewlett-Packard sales office, distributor or representative call:

Americas/Canada: 1-800-235-0312 or 408-654-8675

Far East/Australasia: Call your local HP sales office.

Japan: (81 3) 3335-8152

Europe: Call your local HP sales office.

Data subject to change.
Copyright © 1999 Hewlett-Packard Co.

Obsoletes 5966-4283E

5968-4188E (2/99)